

UV SMD LED with Silicone Lens

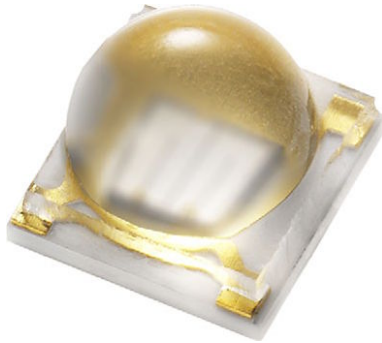

DESCRIPTION

VLMU3510-365-130 is a ceramic based high power UV LED with silicone lens for long life time. The package size is 3.45 mm x 3.45 mm and the radiant power up to 835 mW at 500 mA in a wavelength range of 362.5 nm to 370 nm.

PRODUCT GROUP AND PACKAGE DATA

- Product group: LED
- Package: SMD ceramic high power
- Product series: high power UV LED
- Angle of half intensity: $\pm 65^\circ$
- Lead-finishing: Au

SAFETY ADVICES

Depending on the mode of operation, these devices emit highly concentrated non visible ultraviolet light which can be hazardous to the human eye. Products which incorporate these devices have to follow the safety precautions given in IEC 62471 "Photobiological Safety of Lamps and Lamp Systems".

FEATURES

- Ceramic SMT package with silicone lens
- Dimension (L x W x H) in mm: 3.45 x 3.45 x 2.1
- Forward current: up to 700 mA
- Radiant power (typ.): 690 mW at 500 mA, 945 mW at 700 mA
- Materials:
 - Die: InGaN
 - Resin: silicone (water clear)
 - Leads / terminations finish: gold plated (Au)
- Grouping parameters:
 - Forward voltage
 - Radiant power
 - Peak wavelength
- Reflow soldering method
- MSL 3 according to J-STD-020
- Packaging: MOQ = 1000 pieces; 12 mm tape with 500 pieces per reel, \varnothing 180 mm (7")
- Material categorization: for definitions of compliance please see www.vishay.com/doc?99912



APPLICATIONS

- Industrial curing
- Photocatalytic purification
- Poster printing curing
- Counterfeit money detector
- Blood detector
- Nail curing
- Teeth curing

PARTS TABLE

PART	COLOR	RADIANT POWER (mW)			at I _F (mA)	WAVELENGTH (nm)			at I _F (mA)	FORWARD VOLTAGE (V)			at I _F (mA)	TECHNOLOGY
		MIN.	TYP.	MAX.		MIN.	TYP.	MAX.		MIN.	TYP.	MAX.		
VLMU3510-365-130	Ultraviolet	560	690	835	500	362.5	367	370	500	3.2	4.0	4.4	500	InGaN

ABSOLUTE MAXIMUM RATINGS (T_{amb} = 25 °C, unless otherwise specified) VLMU3510-365-130

PARAMETER	TEST CONDITION	SYMBOL	VALUE	UNIT
DC forward current		I _F	700	mA
Power dissipation		P _V	3	W
Electrostatic discharge	HBM: MIL-STD-883 C 3B	ESD	2000	V
Junction temperature		T _j	+90	°C
Operating temperature range		T _{amb}	-40 to +85	°C
Storage temperature range		T _{stg}	-55 to +90	°C
Solder temperature		T _{sol}	260	°C



OPTICAL AND ELECTRICAL CHARACTERISTICS ($T_{amb} = 25\text{ }^{\circ}\text{C}$, unless otherwise specified) VLMU3510-365-130, ULTRAVIOLET						
PARAMETER	TEST CONDITION	SYMBOL	MIN.	TYP.	MAX.	UNIT
Forward voltage	$I_F = 500\text{ mA}$	V_F	3.2	4.0	4.4	V
Radiant power	$I_F = 350\text{ mA}$	ϕ_e	-	490	-	mW
	$I_F = 500\text{ mA}$		560	690	835	
	$I_F = 700\text{ mA}$		-	945	-	
Radiant intensity	$I_F = 350\text{ mA}$	I_e	-	160	-	mW/sr
	$I_F = 500\text{ mA}$		-	230	-	
	$I_F = 700\text{ mA}$		-	315	-	
Peak wavelength	$I_F = 500\text{ mA}$	λ_p	362.5	367	370	nm
Angle of half intensity	$I_F = 500\text{ mA}$	ϕ	-	± 65	-	deg
Thermal resistance junction to case		R_{thJC}	-	5.1	-	K/W

Note

- Tolerances: $\pm 11\%$ for ϕ_e , $\pm 0.1\text{ V}$ for V_F , $\pm 3\text{ nm}$ for λ_p .

RADIANT POWER CLASSIFICATION ($I_F = 500\text{ mA}$)			
GROUP	MIN.	MAX.	UNIT
GH	560	610	mW
HI	610	665	
IJ	665	720	
JK	720	775	
KL	775	835	

PEAK WAVELENGTH CLASSIFICATION ($I_F = 500\text{ mA}$)			
GROUP	MIN.	MAX.	UNIT
P3M2	362.5	365	nm
P3N1	365	367.5	
P3N2	367.5	370	

FORWARD VOLTAGE CLASSIFICATION ($I_F = 500\text{ mA}$)			
GROUP	MIN.	MAX.	UNIT
V1	3.2	3.6	V
V2	3.6	4.0	
V3	4.0	4.4	

Note

- In order to ensure availability, single groups for radiant intensity, wavelength, and forward voltage will not be orderable. Only one group for radiant intensity, wavelength, and forward voltage will be shipped in any one reel.

MARKING EXAMPLE FOR SELECTION CODE ON LABEL

Selection code: IJ-P3N1-V2

- IJ range: 665 mW to 720 mW
- P3N1 range: 365 nm to 367.5 nm
- V2 range: 3.6 V to 4.0 V

TYPICAL CHARACTERISTICS ($T_{amb} = 25\text{ }^{\circ}\text{C}$, unless otherwise specified)

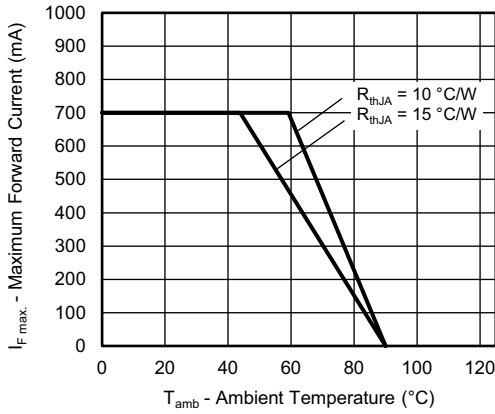

Fig. 1 - Maximum Forward Current vs. Ambient Temperature

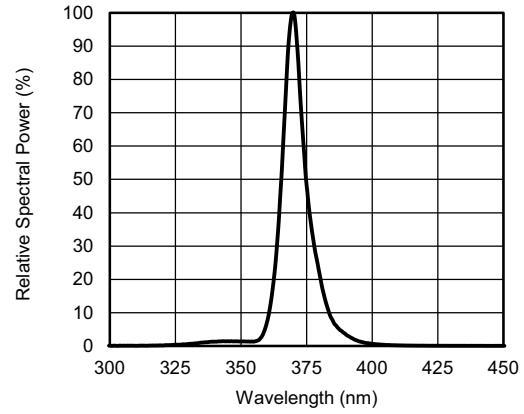

Fig. 4 - Relative Spectral Power vs. Wavelength

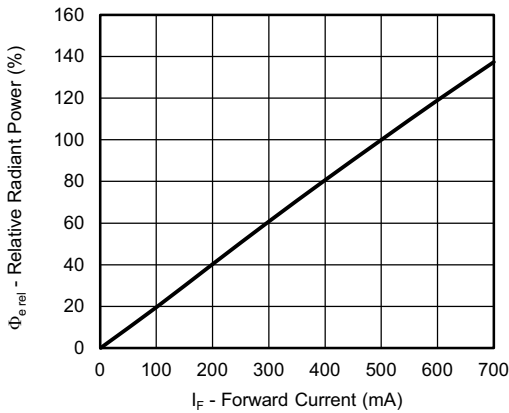

Fig. 2 - Relative Radiant Power vs. Forward Current

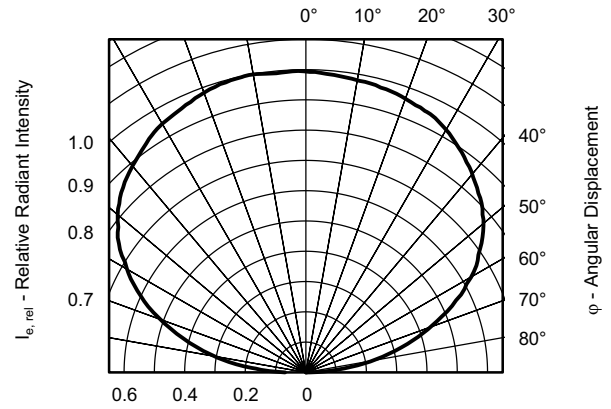

Fig. 5 - Relative Radiant Intensity vs. Angular Displacement

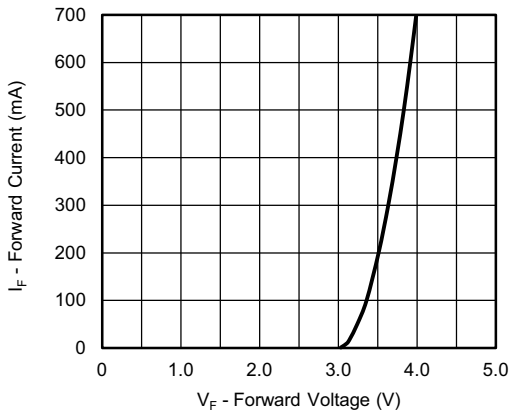

Fig. 3 - Forward Current vs. Forward Voltage

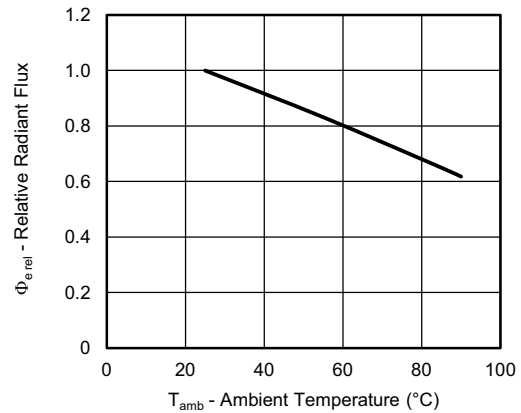
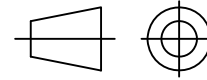
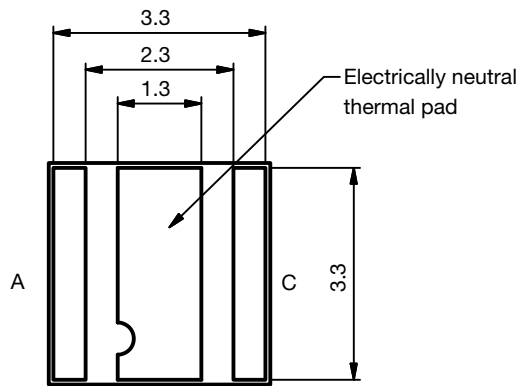

Fig. 6 - Relative Radiant Flux vs. Ambient Temperature



PACKAGE DIMENSIONS in millimeters



Technical drawings according to DIN specification.

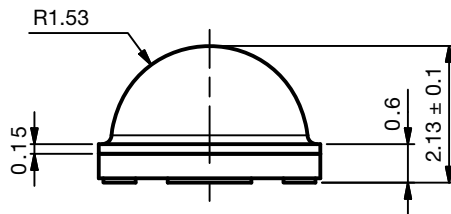

Not indicated tolerances ± 0.2

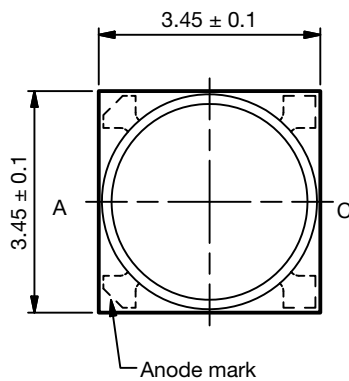

Recommended solder pad footprint

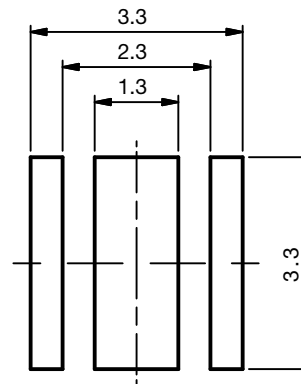

Drawing-No.: 6.541-5112.01-4
Issue: prel; 27.01.16

WIRING

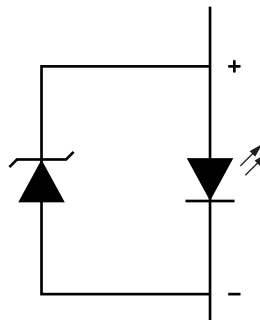
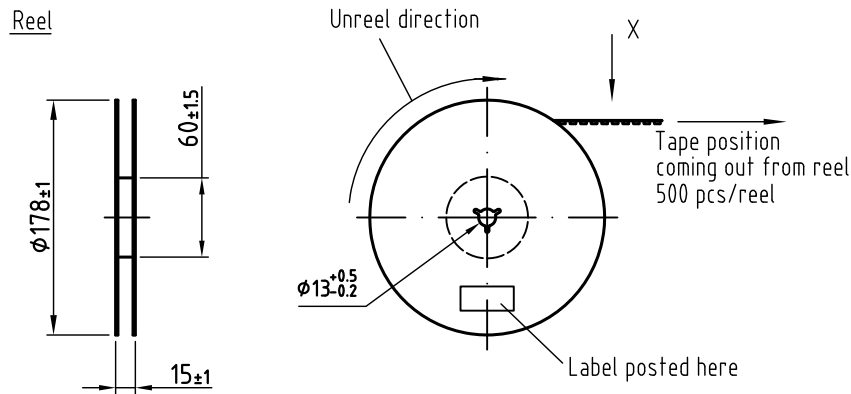
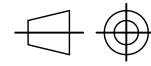

Fig. 7 - Wiring Diagram

TAPE AND REEL DIMENSIONS in millimeters



All dimensions in mm



technical drawings according to DIN specifications

Leader and trailer tape:

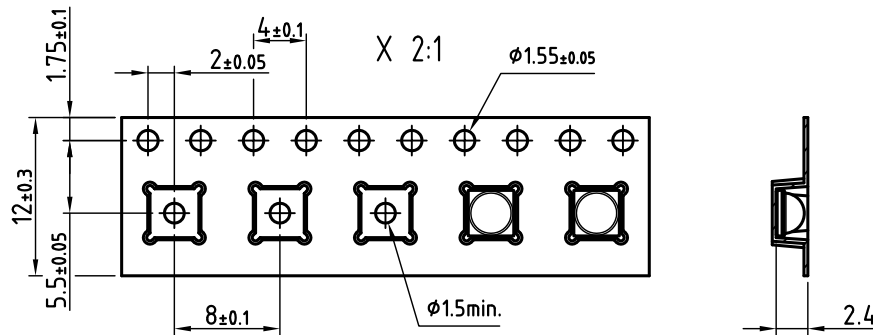
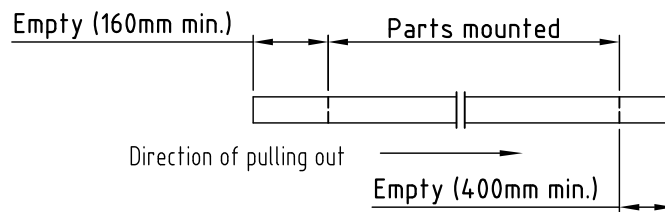

Drawing refers to following types: VLMU3510...
Reel dimensions and tape

Drawing-No.: 9.800-5139.01-4
Issue: prel; 02.03.16

MOQ: 1000 pieces (2 reels each with 500 pieces)

SOLDERING PROFILE

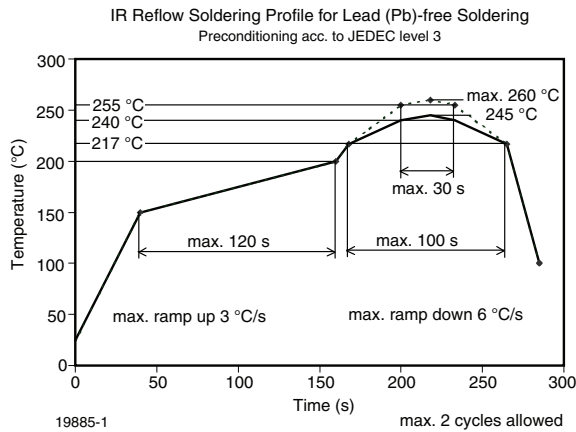
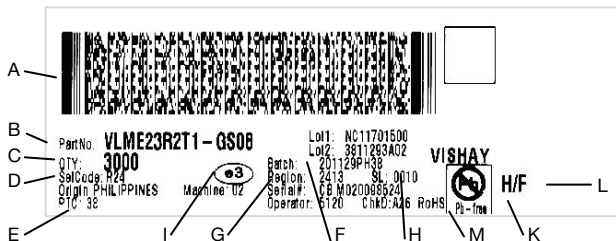

Fig. 8 - Vishay Lead (Pb)-free Reflow Soldering Profile (acc. to J-STD-020C)

BAR CODE PRODUCT LABEL (example only)



- a. 2D barcode
- b. Vishay part number
- c. Quantity
- d. SEL = selection code (binning)
- e. Code of manufacturing plant
- f. Batch = date code: year/week/plant code
- g. Region code
- h. SL = sales location
- i. Terminations finishing
- j. Lead (Pb)-free symbol
- k. Halogen-free symbol
- l. RoHS symbol

DRY PACKING

The reel is packed in an anti-humidity bag to protect the devices from absorbing moisture during transportation and storage.

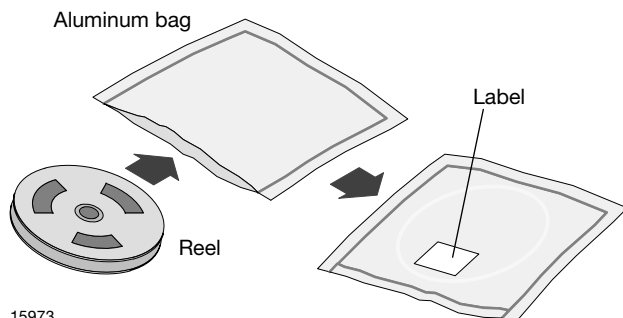

15973

FINAL PACKING

The sealed reel is packed into a cardboard box. A secondary cardboard box is used for shipping purposes.

RECOMMENDED METHOD OF STORAGE

Dry box storage is recommended as soon as the aluminum bag has been opened to prevent moisture absorption. The following conditions should be observed, if dry boxes are not available:

- Storage temperature 10 °C to 30 °C
- Storage humidity ≤ 60 % RH max.

After more than 168 h under these conditions moisture content will be too high for reflow soldering.

In case of moisture absorption, the devices will recover to the former condition by drying under the following condition:

- 192 h at 40 °C + 5 °C / - 0 °C and < 5 % RH (dry air / nitrogen) or
- 24 h at 60 °C + 5 °C and < 5 % RH for all device containers or
- 24 h at 100 °C + 5 °C not suitable for reel or tubes.

An EIA JEDEC® standard JESD22-A112 level 3 label is included on all dry bags.

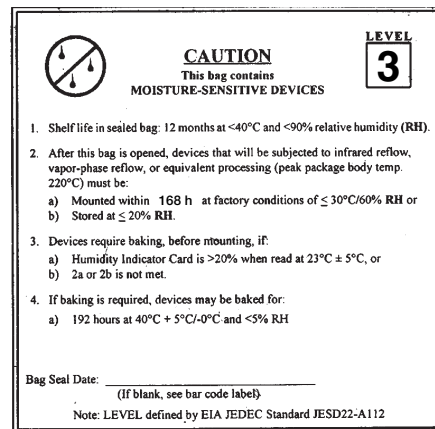

17028-2

Example of JESD22-A112 level 3 label

ESD PRECAUTION

Proper storage and handling procedures should be followed to prevent ESD damage to the devices especially when they are removed from the antistatic shielding bag. Electrostatic sensitive devices warning labels are on the packaging.

VISHAY SEMICONDUCTORS STANDARD BAR CODE LABELS

The Vishay Semiconductors standard bar code labels are printed at final packing areas. The labels are on each packing unit and contain Vishay Semiconductors specific data.



Disclaimer

ALL PRODUCT, PRODUCT SPECIFICATIONS AND DATA ARE SUBJECT TO CHANGE WITHOUT NOTICE TO IMPROVE RELIABILITY, FUNCTION OR DESIGN OR OTHERWISE.

Vishay Intertechnology, Inc., its affiliates, agents, and employees, and all persons acting on its or their behalf (collectively, "Vishay"), disclaim any and all liability for any errors, inaccuracies or incompleteness contained in any datasheet or in any other disclosure relating to any product.

Vishay makes no warranty, representation or guarantee regarding the suitability of the products for any particular purpose or the continuing production of any product. To the maximum extent permitted by applicable law, Vishay disclaims (i) any and all liability arising out of the application or use of any product, (ii) any and all liability, including without limitation special, consequential or incidental damages, and (iii) any and all implied warranties, including warranties of fitness for particular purpose, non-infringement and merchantability.

Statements regarding the suitability of products for certain types of applications are based on Vishay's knowledge of typical requirements that are often placed on Vishay products in generic applications. Such statements are not binding statements about the suitability of products for a particular application. It is the customer's responsibility to validate that a particular product with the properties described in the product specification is suitable for use in a particular application. Parameters provided in datasheets and / or specifications may vary in different applications and performance may vary over time. All operating parameters, including typical parameters, must be validated for each customer application by the customer's technical experts. Product specifications do not expand or otherwise modify Vishay's terms and conditions of purchase, including but not limited to the warranty expressed therein.

Except as expressly indicated in writing, Vishay products are not designed for use in medical, life-saving, or life-sustaining applications or for any other application in which the failure of the Vishay product could result in personal injury or death. Customers using or selling Vishay products not expressly indicated for use in such applications do so at their own risk. Please contact authorized Vishay personnel to obtain written terms and conditions regarding products designed for such applications.

No license, express or implied, by estoppel or otherwise, to any intellectual property rights is granted by this document or by any conduct of Vishay. Product names and markings noted herein may be trademarks of their respective owners.

Mouser Electronics

Authorized Distributor

Click to View Pricing, Inventory, Delivery & Lifecycle Information:

[Vishay:](#)

[VLMU3510-365-130](#)